

# Smart camera for machine vision

FHV7 Series

## Bring advanced product inspection within reach

A powerful, all-in-one camera system with advanced image processing functions



# The functionality and speed that your production site demands packed in an all-in-one device

The FHV7 Smart Camera is an all-in-one solution that packs the broad capabilities of the FH Series Vision System into a compact, configurable and easy-to-deploy package.

This powerful smart camera includes all of the FH Series' most popular inspection and measurement functions and makes these capabilities accessible to a wider range of applications. In places where automated inspection was once impractical due to high costs, space constraints and durability issues, the FHV7 now provides a highly effective

Integrated controller structure

**Smart camera**  
**FHV7 Series**



Challenges in adjusting to product variation

Rapidly responds to inspection target changes

P.8

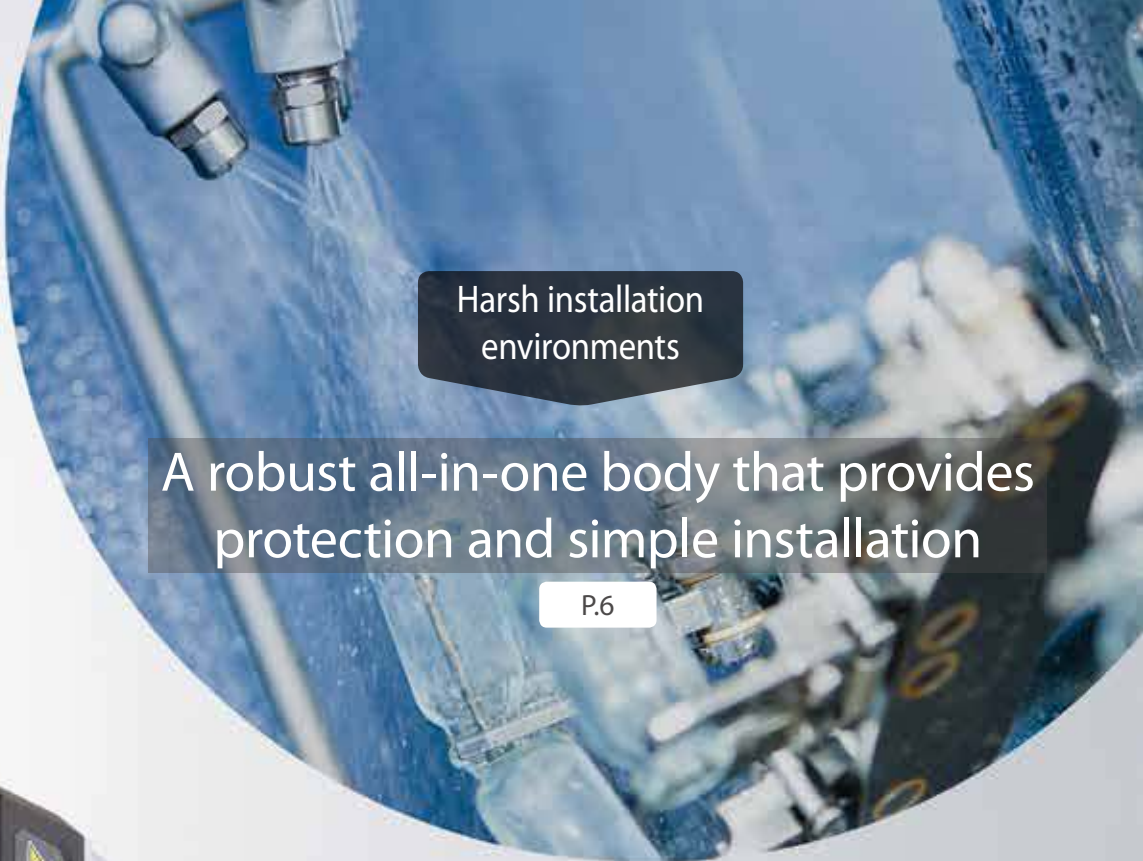

Harsh installation environments

A robust all-in-one body that provides protection and simple installation

P.6



Constant requirement to improve manufacturing agility, speed, and quality

Processing power that facilitates rapid inspection

P.10

# Nearly-infinite combinations to fit any production scenario

## Smart Camera



PROFI®  
NETX  
Ethernet/IP  
Ethernet  
EtherCAT® \*1

## Lenses



High-speed autofocus **NEW**  
6/19 mm



Standard autofocus  
6/9/12/16/25 mm

### Module Auto-adjust function **PATENT PENDING** \*2

This function automatically adjusts according to the mounted lens module so that the image sensor has uniform light sensitivity throughout its area.



C mount lenses (examples)

## Image sensors (color/monochrome)

### Global shutter

0.4 Mpix	1.6 Mpix
3.2 Mpix	5 Mpix

### Rolling shutter

6.3 Mpix	12 Mpix
----------	---------



## Waterproof hood

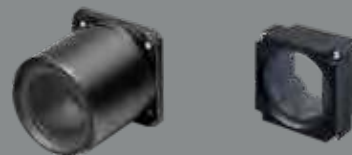

This component is required to ensure IP67 protection without using a lighting module.

\*1. The FHV-SDU30 EtherCAT® Interface is required for EtherCAT connection.

\*2. "Patent pending" means that we applied for a patent in Japan, and "Patented" means that we obtained a patent in Japan. (As of April 2019)

The FHV7 provides multiple component options so that you can freely combine lens and lighting types and easily adjust the optical conditions for specific products. The camera's footprint is not affected by module replacement. Even if a sudden change occurs in the product specification, only minor rearrangements are required.

All-in-one models with lens and light modules are also available.

## Modules

### Lights



Multi-color (R/G/B/IR)



Red



IR



White

### Optical Filters



Diffusion filter



Polarization filter (visible light)



Polarization filter (infrared and visible light)

### Easy connection with FLV/FL External Lights



You can select from a broad lineup of more than 150 models.

# A robust all-in-one body that makes it easy to install

## Installable anywhere

### Integrated camera/controller structure

Everything you need for image processing is included. The all-in-one structure provides not only the controller but also the lens and lighting. This allows for simple and compact installation without any additional cabling, bracketry, external I/O or control panel space.

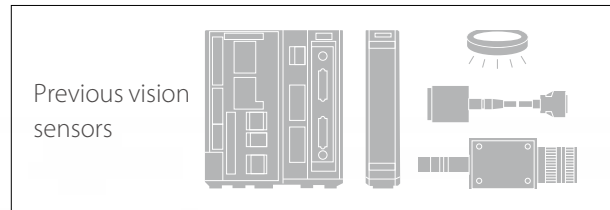

**Easy-to-replace modular structure**

Lens and lights are available as modules. Easily serviceable and upgradeable in the event of damage or inspection requirements changes.

## Robust structure

### IP67 waterproof housing and connectors

IP67 rating allows for use in harsh conditions, such as regular wash-downs of the area where the cameras are installed.



### Captive screws

Serviceable components use captive screws, preventing problems caused by the screws falling into the production line and not properly re-sealing the camera housing.



### Replaceable covers

The light cover and optical filter are easy to remove and clean, or replace, providing effective camera protection against dirt.



Dirty cover filters can be removed separately for replacement

## High scalability

### External lights supported

The Omron FLV and FL Lighting Series consist of a wide offering of more than 150 models, and can easily be attached as external lights to FHV7 Smart Cameras.

By connecting the lighting controller, you can, via the FHV7 configuration setting menu, easily adjust the lighting intensity and set strobing to synchronize with the activation of the camera shutter.



# Rapidly responds to inspection target changes



## Multi-color Light

### Accommodates color variations

Multi-color light provides a quick solution to the issue of optimizing image capture for different colors. For example, objects with differently colored packages on a production line are best illuminated with lighting that can change its color based on the color of the target object. When a product design is changed or new products are added, you can simply change a camera parameter instead of replacing or fine-tuning lights. The vision inspection system is always ready for a broad variety of products.



## Autofocus Lens

### Accommodates size variations

The autofocus lens covers a focal length range from 59 mm to 2,000 mm<sup>\*1</sup>. Even when products in different sizes are produced, the focus range can be changed easily by parameters<sup>\*2</sup>. This feature eliminates mechanical operation for changeover during product replacement, leading to a simpler system with higher productivity and error proofing.

\*1. Differs depending on the lens type. See the optical charts on the datasheet for details.

\*2. Set focuses for different product heights in advance and switch between them when you perform a changeover.



## Best-in-class resolution<sup>\*3</sup>:

### Large inspection area capabilities

The high resolution image sensor enables high precision inspections of large fields of view. This eliminates the need for installing multiple cameras or a mechanism to move a camera to capture different inspection points of different products produced on the same production line.

\*3. Based on Omron investigation in October 2018.



## When inspecting products of different colors

When a product has several color options, some colors may cause low contrast under single-color illumination. Our multi-color lighting ensures stable inspections when different product color options are presented.



## When inspecting products of different sizes

When inspecting products such as plastic bottles that come in different sizes, you can perform a changeover only by switching the setting of the autofocus lens. The autofocus lens does not require mechanical adjustment.

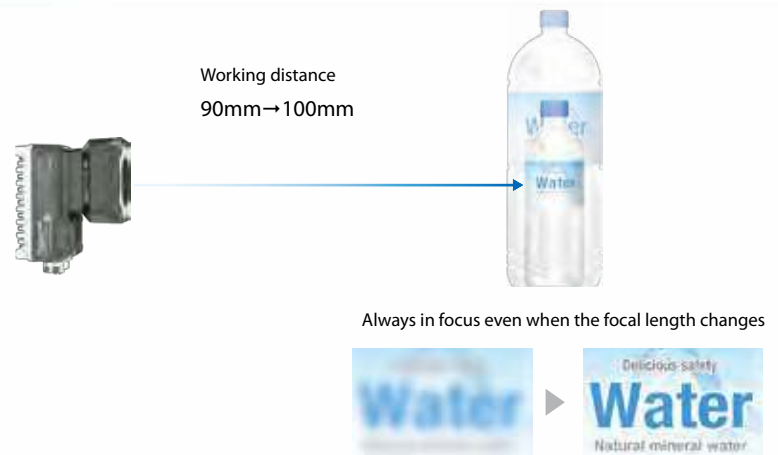

## Expanding the inspection area

Accurate and extensive inspection of fasteners locations for different automobile models is enabled without moving or adding cameras.



# Excellent productivity performance



**Best-in-class speed\*<sup>1</sup>**  
Image capture  
Maximum speed 2.3 ms  
×  
Distributed processing  
across 2 cores  
×  
High-speed algorithm

## Processing power that facilitates rapid inspection

The all-in-one FHV7 Smart Camera is packed with capabilities carried over from the FH Series. Its high performance, comparable to a dedicated image processing system, enables advanced applications.



## Clear images facilitate inspection

The FHV7 Smart Camera can inspect a 1.6 megapixels image in 24 ms. It can perform high-resolution inspections without compromising speed capabilities and can be used in places where image processing systems are currently deployed.

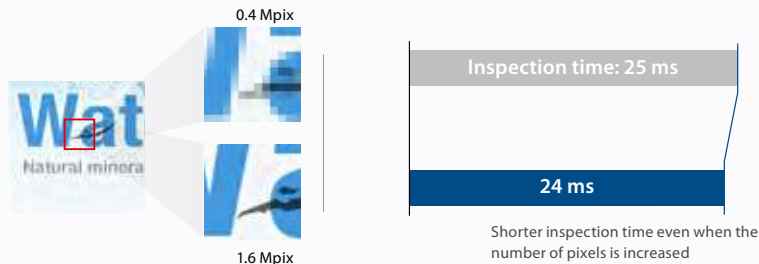

## More inspection points

FHV7's high processing performance enables you to easily conduct inspections equivalent to an image processing system. It is optimal for multipoint inspections that would significantly compromise speed when conducted with traditional smart cameras.

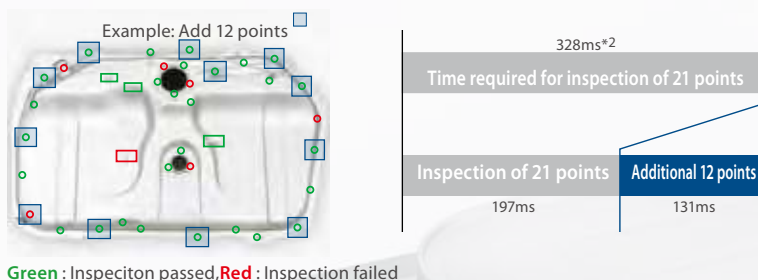

Green : Inspection passed, Red : Inspection failed

## Settings can be adjusted with zero downtime

Measured values may change gradually due to product variation or changes in external conditions. Even in such cases, distributed processing across 2 cores allows you to perform cause analysis and make setting adjustments while you continue to operate. This helps eliminate false rejects and eliminates production downtime associated with making setting changes.

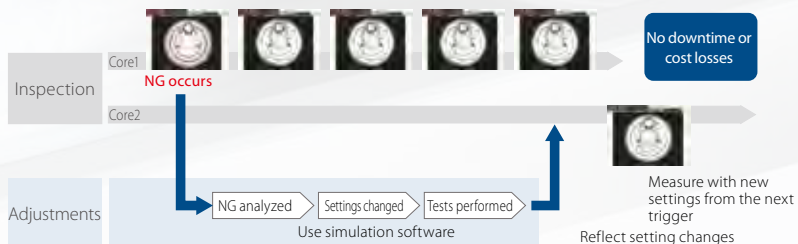

\*1. Based on Omron investigation in October 2018.

\*2. Sample comparison to inspection time using vision sensors installed in customer's machine. Based on Omron investigation in October 2018

# Traceability and serial number management

## Application Examples

The FHV7 Smart Camera is suitable for applications in which inspection results and images are managed by product serial numbers.

## Stable reading regardless of printing quality

### 2D Code II algorithm delivers powerful code reading

A robust algorithm for stable 2D code reading under adverse conditions is included. Barcode quality data based on relevant ISO standards can be output, identifying changes to barcode printing or direct part mark quality.

Changing ambient brightness

Chips due to reflection      Low contrast

After processing/washing

Waterdrops and dirt      Scratched damage

Poor printing quality in high-speed line      Poor printing quality on coarse surface

Variations in start positions

Uneven line spacing

Molding variations of forged object

Print Quality Grading Function

- ISO/IEC 15415
- ISO/IEC TR29158

### Stable reading of difficult-to-read characters (OCR)

Printed characters with close spacing and characters printed on curved surfaces can be reliably identified. Plus signs can also now be read.

Touching characters

Curved character strings

Plus signs NEW

### Easy installation with built-in dictionary

Many previous character reading methods required dictionary setup before usage, which was a tedious step. The built-in dictionary includes a variety of fonts and possible character variations, eliminating the need of dictionary setup. You can also add non-conventional characters when special fonts are read.

Characters from most printers can be read, including dot and impact printers.

Approx. 80 fonts are supported

Laser printer

Inkjet printer

Thermal printer

Laser marker

## High-speed image storage and image compression

Image data is so large that conventional controllers could not store all images due to limited storage time and storage capacity. The FHV7 Smart Camera has algorithms and hardware that can save images in Omron formats and compress image data at high speed, enabling all images to be stored to meet increasing needs in quality control.

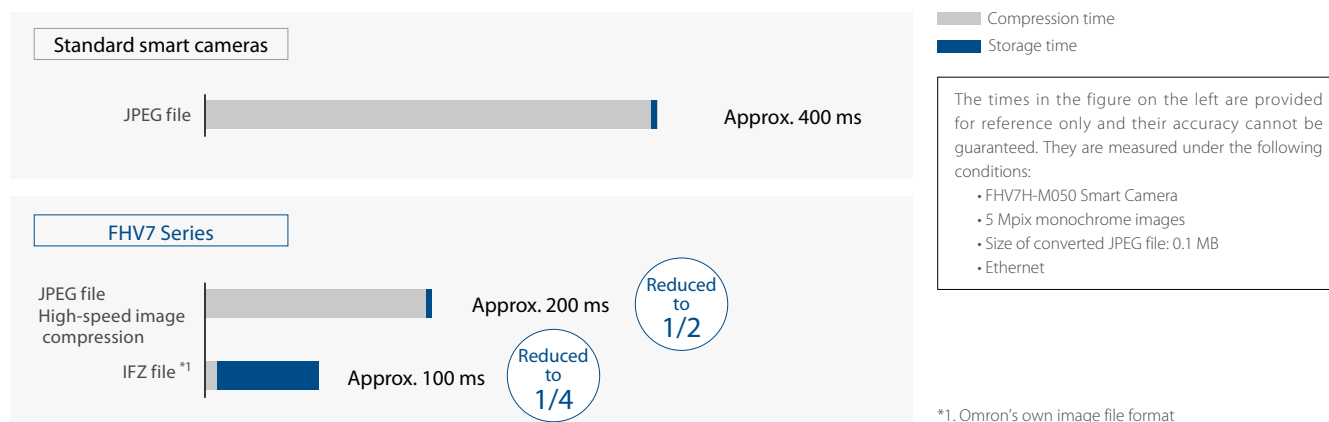

## High-speed image storage

### Images are saved in parallel with image inspection

Distributed processing across 2 cores allows the CPU to perform parallel processing of inspections and image logging. With connection to a high-speed, large-capacity network storage device, all images on the high-speed line can be saved, previously difficult to achieve.\*

Trend analysis of all saved images quickly isolates errors and facilitates countermeasures.

- \* All images can be saved under the following conditions:
- One 0.4 Mpix camera
  - Measurement time of 30 ms
  - JPEG file
  - Images can be saved continuously for approx. 380 days when a 3 TB NAS is used (based on 8 hours of operation a day)

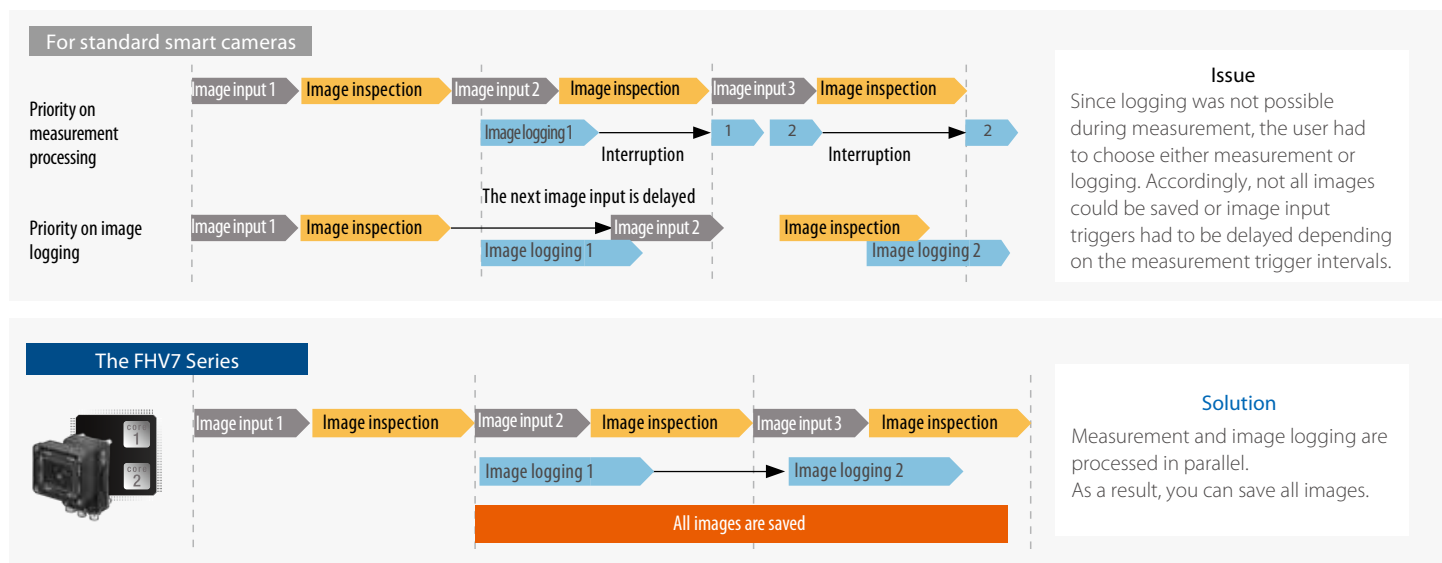

# Flexible multipoint inspection using robots

## Application Examples

The FHV7 Smart Camera can be installed on robot arms to inspect objects from multiple directions.

## Vision inspection suited to each location

The FHV7 Smart Camera, which is moved to each inspection point, adjusts field of view, precision, and focus to match the location.

External inspection by the human eye can be replaced with automated inspection using robots.

### Presence inspection of brackets

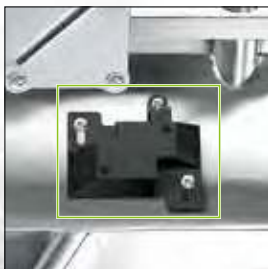

### Reading direct part marks

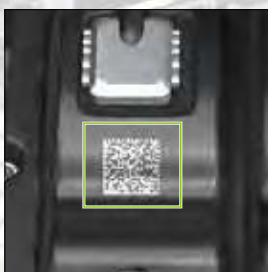

### Presence inspection of marked characters



Clear images  
stabilize  
inspections

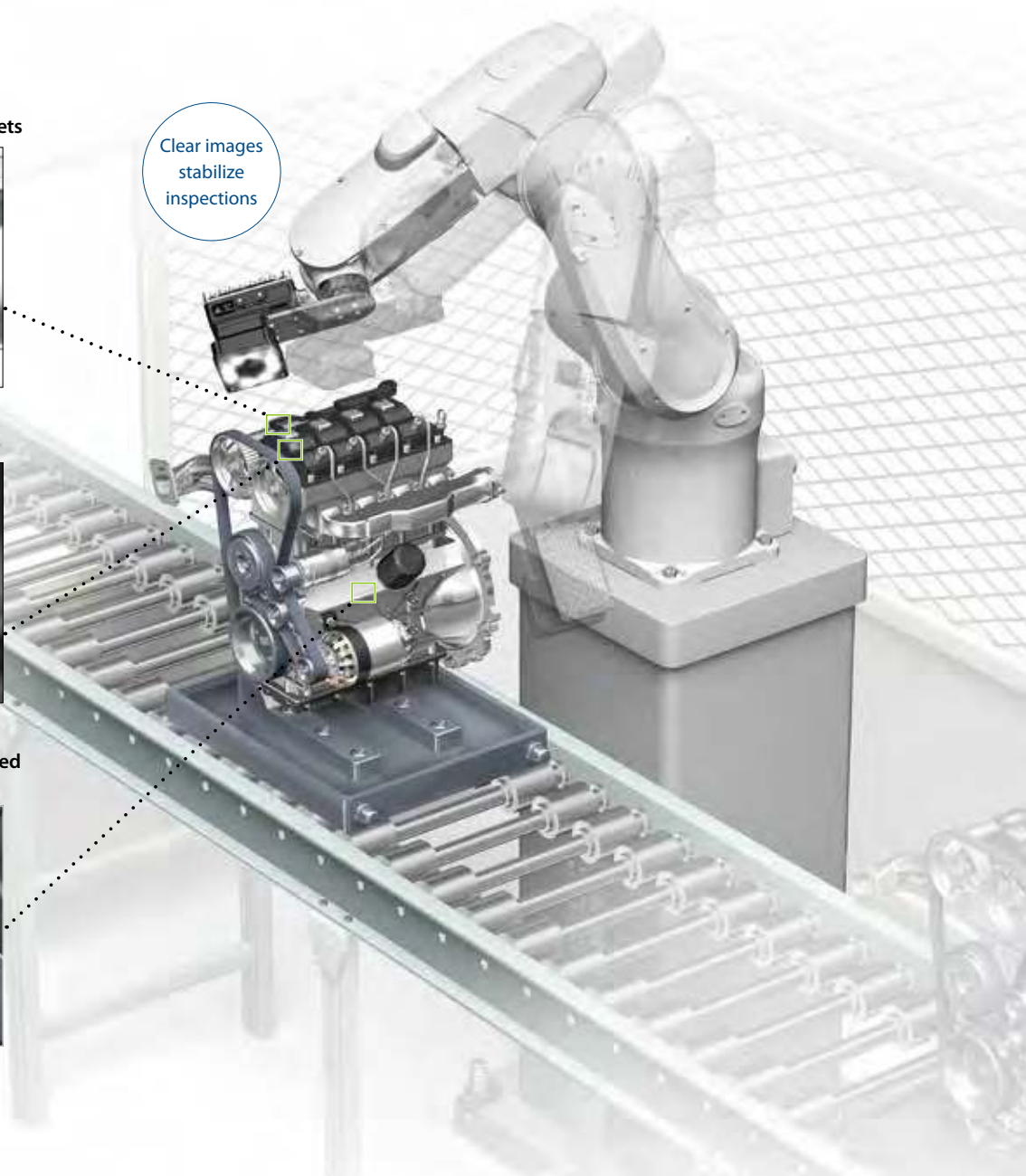

## Ultra-high-speed, long-life lens module

NEW

PATENT PENDING \*1

New high-speed lens modules using a liquid lens have been added to the lineup. Advanced control of the liquid lens enables the lens to focus about 10 times faster than a mechanical focus lens, allowing settings to be changed during movement of the robot arm.\*2 General mechanical focus mechanisms break due to deterioration of the drive mechanism or motor when they perform autofocus tens of thousands of times. The liquid lens provides unlimited autofocus and long life.

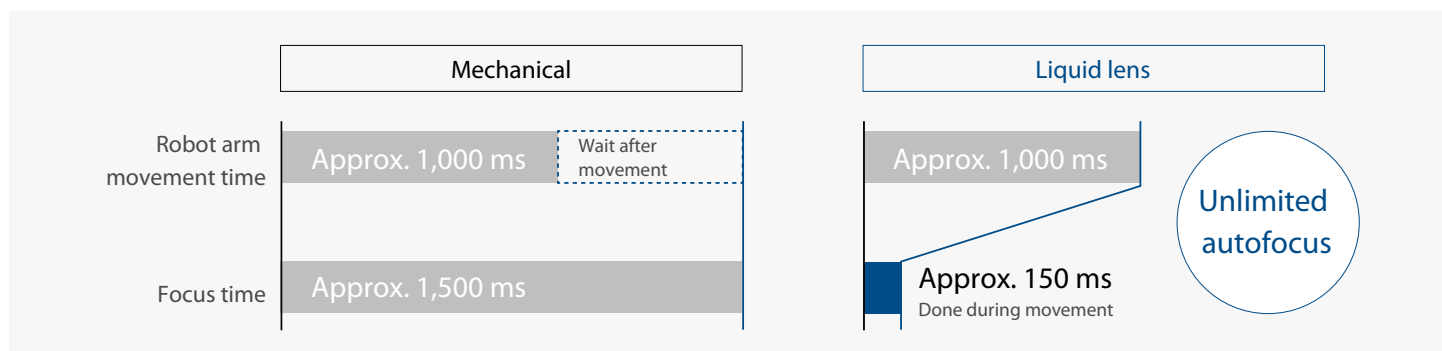

Note: The above times are when the focus value is changed from minimum to maximum. These times are provided for reference only and are not guaranteed.

\*1. "Patent pending" means that we applied for a patent in Japan, and "Patented" means that we obtained a patent in Japan. (As of April 2019)

\*2. Set focuses for different product heights in advance and switch between them.

## Much less maintenance

### Super-flexible cable NEW

The new cable offers approximately 10 times the bending resistance of conventional FHV7 flexible cables. High bending resistance significantly reduces the frequency of replacing the cables on robot arms.



## Reduces halation from metallic or glossy surfaces NEW

The High Dynamic Range (HDR) function minimizes the influence of changes in lighting conditions and light reflection. This enables stable inspections even for materials that are difficult to light evenly, such as metal parts or glossy films, or in locations subject to external light interference.



# Filtering to emphasize difficult-to-find defects

Image input & filtering

**18**  
processing items

## Stripe Removal Filter II

The stripped pattern is filtered out so that only required aspects are shown clearly. Vertical, horizontal, and diagonal stripes can be removed.



## Anti Color Shading **PATENTED** \*

Specific shades that hide defects are removed so that tiny scratches and dirt can be precisely detected. This advanced filtering was achieved through the Real Color Sensing technology.



## Even Emphasis Unevenness

This filter removes background pattern and enhances low-contrast unevenness.

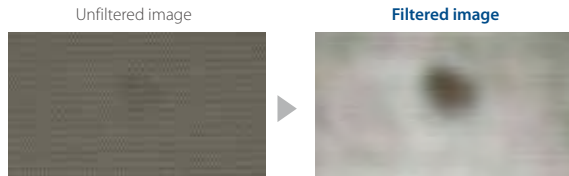

## Emphasis Line Defect/Emphasis Circle Defect

These filters enhance defects in high background noise or scratches on embossed surfaces.

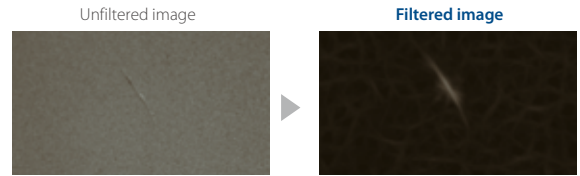

## Brightness Correct Filter

This filter cuts out uneven lighting and changes in brightness caused by workpiece surface irregularities to make characteristic features stand out clearly.

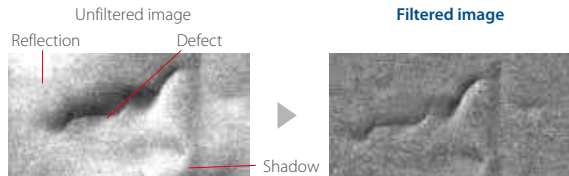

The wavy inconsistencies are judged as defects.

Uneven areas are removed so that only the defect appears in the inspection.

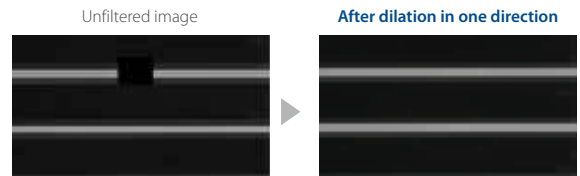

## Custom Filter

You can set the mask coefficients as required for these filters. The mask size can be up to 21 x 21. You can flexibly set smoothing, edge extraction, dilation, and erosion for the image.

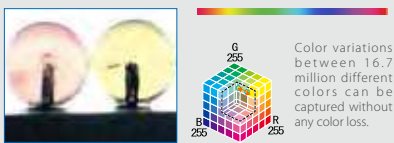
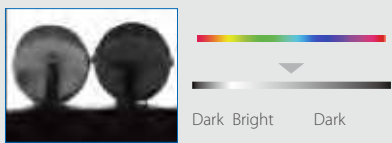

## Real Color Sensing **PATENTED** \*

Real-color processing is an image processing technology that performs high-speed processing of full-color images with a total of 16.7 million colors (256 tones per RGB channel). This means that image processing can be performed with the same color information that is visible to the human eye, and stable measurements can be performed under lighting that closely resembles natural light.

Real Color Sensing	Color image processing	Color segmentation processing
 <p>Color variations between 16.7 million different colors can be captured without any color loss.</p>	 <p>Dark Bright Dark</p>	 <p>Black White Black</p>
<p>The camera image is processed as-is without any loss of quality. This enables even the slightest of color differences to be captured with high accuracy.</p>	<p>Captured images are converted to a 256-shade monochrome image and processed. This enables more stable inspection compared to binary level processing, but slight changes in color cannot be detected with this method.</p>	<p>Captured images are converted to a black and white two-color image and processed. This reduces the amount of data and enables high-speed processing.</p>

\* "Patent pending" means that we applied for a patent in Japan, and "Patented" means that we obtained a patent in Japan. (As of April 2019)



# Processing items for various types of inspections

Inspection & measurement

27  
processing items

## Precise Defect

### Detection of dirt on paper cups

This processing item is used to detect scratches and dirt on paper cups and molded plastics, as well as oil stains on metal surfaces. Real Color Sensing makes it possible to detect dirt in various colors.

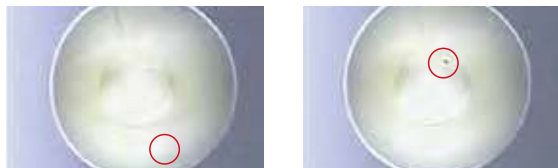

## Search II

**NEW** 2 times faster and higher detection\*

### Cable arrangement inspection

Just register a model, and the cable arrangement inspection is completed in one go. Repeating color detection is not necessary.

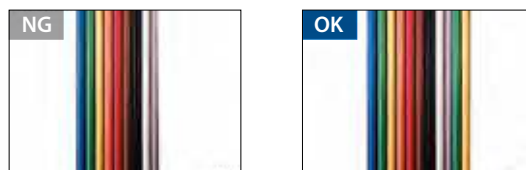

\* Compared with Search under our test conditions in April 2019.

## Scan Edge Position and Scan Edge Width

### Inspection of groove depth of metal shafts

The maximum and minimum widths within the region are measured simultaneously. This processing item is very useful especially for the measurement of groove depths of metal shafts.

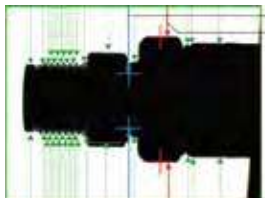

## Fine Matching

### Inspection for label rips

The registered reference image is compared against the input image and tiny differences are detected at high speed. Scratches on the intricate patterns and unexpected dirt in the color are precisely detected.

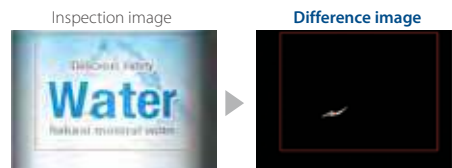

## Labeling

### Hole counting

The number of labels with the specified color and size is counted. Also, the area and center of gravity of the specified labels are measured.



## Glue Bead Inspection

### Path and width inspection

Just define the start and end points of the object to evaluate sealing numerically. This minimizes inconsistencies in inspection. This method enables accurate inspection of complex curves and interruptions.



## Character Inspection

### Label printing inspection

Characters are recognized by pattern search, and this enables special fonts and non-alphanumeric characters to be inspected. Automatically extracting a model and selecting an index from the list help you easily set up your dictionary. Using the user dictionary, the Character Inspection performs pattern search to recognize characters.

Auto model extraction  
(Special fonts can be read)



Index selection from list



# Easy-to-use system with high functionality

## Easy measurement flow creation

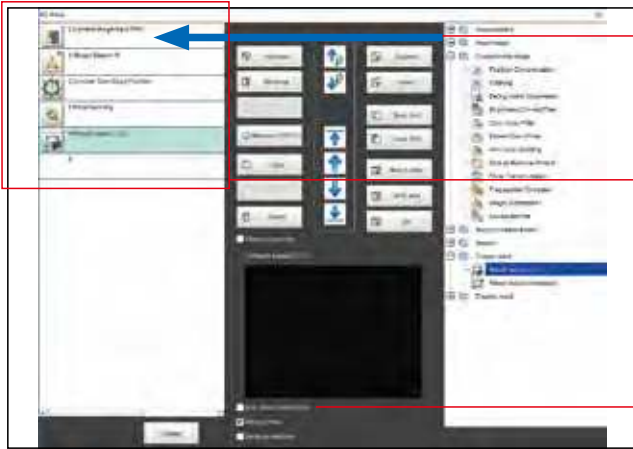

### Drag and drop

Just drag and drop pre-installed processing items from the processing item list to the flowchart to build a measurement flow.



Complex and long processes can be grouped into folders.

### Copy & paste processing items from other scenes



You can set up a new flow menu by combining different processing items copied from other scenes. When reusing the setting of other scenes, you don't need to make adjustments.

## Simple setting with menus

### Total Design Management Editor

The design interface allows you to design complex measurement processes while managing variables. This simple GUI manages complicated branching processes and data sharing across measurement scenes and eliminates the need to switch screens.

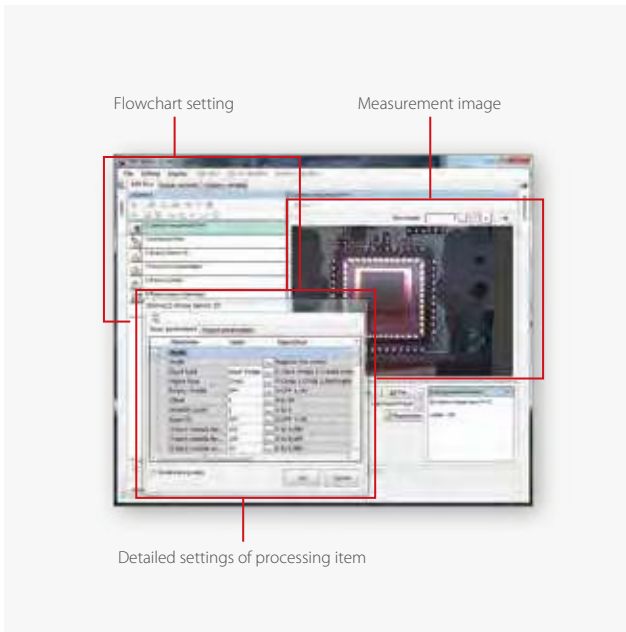

## Setting and operating from a computer

Use a dedicated software to create measurement flows and measurement conditions. The software can also be used for remote monitoring and control via a network.

You can download the software for free after purchasing the product and signing up online. For details, see the member registration sheet attached to the FHV7 Smart Camera.

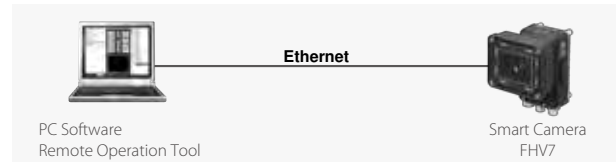

## Operation via touch panel monitor NEW

The touch panel monitor with pre-installed software for the FHV7 Smart Camera can be used as an easy-to-install operator interface.



## Customizable user interface prevents incorrect operation

The processing item setting window includes parameters for initial setting and for daily adjustments. To prevent incorrect operation, you can customize the adjustment window to show only parameters that are required for your daily operation.

Example 1: Show only necessary parameters



Example 2: Show a wizard



### Easy setting

Just select objects from the list in the dialog box and place them. No programming is required.



- Label:**  
Any character string can be displayed in any desired position
- Drop-down list:** Options can be set
- Button:**  
Operation that is performed when the button is pressed can be set

## Easy machine control design NEW

Connecting Sysmac devices via EtherCAT and using the integrated development environment Sysmac Studio allow you to design machine operation as you want.

### One Connection

From position detection to positioning, high-speed data transmission via EtherCAT® enables smooth and flexible control.

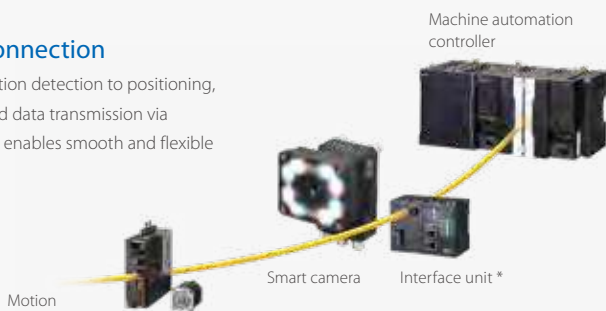

### One Software

Programming devices on EtherCAT from the integrated interface reduces setup times.



## Easy connection to field networks

### EtherCAT \*, EtherNet/IP, PROFINET

The FHV7 Smart Camera includes communication interfaces for compatibility with a wide range of network protocols used at production sites. This helps reduce the design work required for data communications between the camera and a PLC.

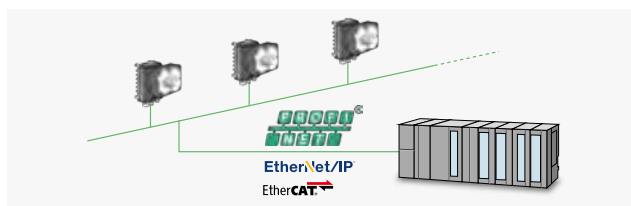

### Easy setting of output items

Just select variables to output measurement results.

No.	Chkset	Data Type	Data	Value
0	0	Integer	123	
1	4	Double	123.456	
2	12	String	ABCDE	
3				

\* The FHV-SDU30 EtherCAT Interface is required for EtherCAT connection.

# Pick and place



## Application Examples

The FHV7 Smart Camera can be combined with robots for picking and assembling applications.

## Shape Search III stably detects all types of objects

Stable position detection is performed regardless of shape, material, or background.

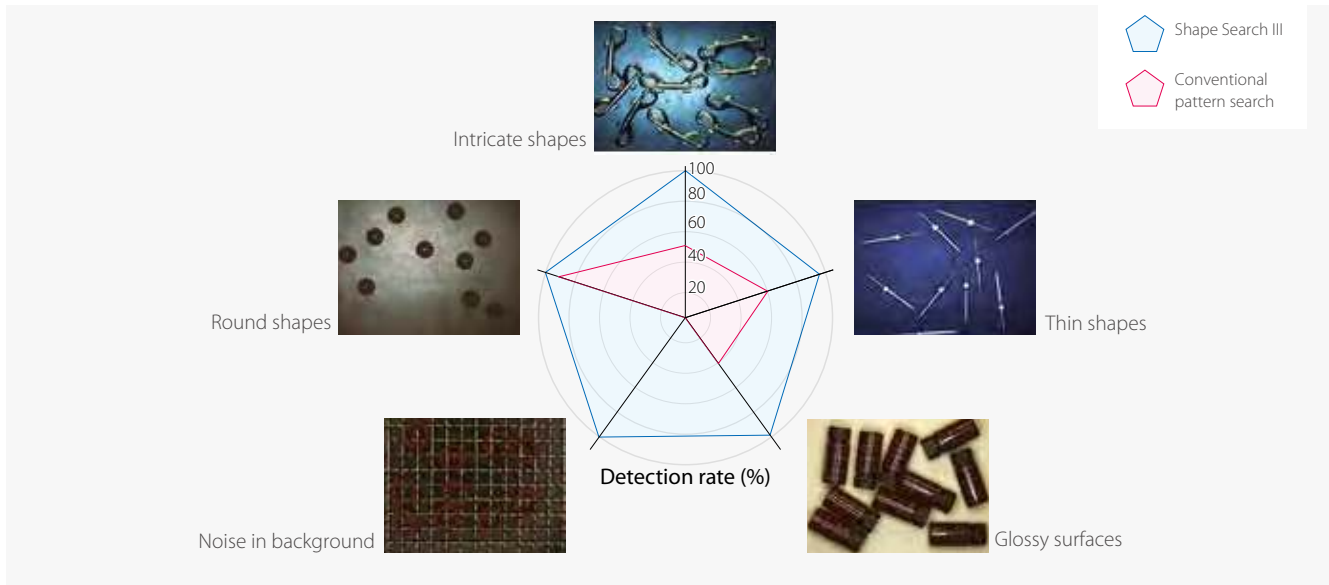

## Sorting mixed products

Different types of objects can be sorted.



Think & See,  
the core technology of Shape Search III



"Think & See" is Omron's powerful core technology for image sensing. Omron is continuously developing technologies to measure, detect, or identify the positions, orientations, shapes, materials, colors, status, or attributes of things, people, vehicles, or other objects faster, more precisely, and more easily than the human eye under various conditions.



See the details of  
Think & See.

<https://www.fa.omron.co.jp/tse>

## Easy output to major robot manufacturers' devices

The configuration settings for FHV7 interface to programs for various robot suppliers, greatly reducing the set-up time for robot applications.



Pick



Offset compensation



Place

### 3-step easy setting

Verified robot communication programs and flowcharts required for robot applications are provided. You don't need to design communications and create a flowchart to set up a robot application.

#### STEP 1

Obtain robot program and flowchart

#### Just a few clicks in Robot Setting Tool

Select 3 items to obtain the communication program and flowchart you need.

You can download the Robot Setting Tool from the following URL:  
<http://www.ia.omron.com/fhv>

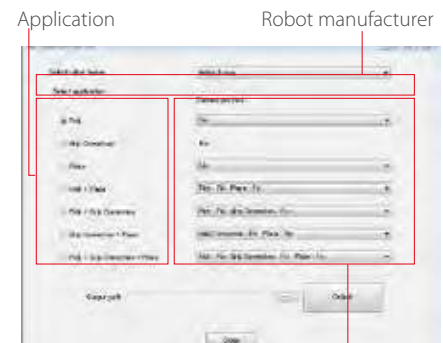

Robot Setting Tool

Camera position

#### STEP 2

Calibrate

#### Move robot for calibration from the FHV7 Series

The obtained flowchart can be used to move the robot for calibration from the FHV7 Smart Camera. There is no need to create a program for robot calibration.

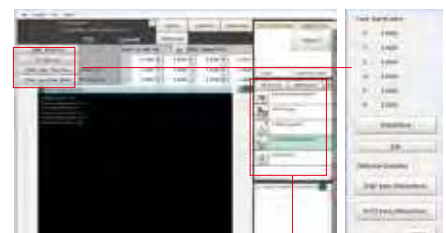

Flowchart

Move robot

#### STEP 3

Check operations

#### Set up and check application from the FHV7 Series

Set the coordinates of the robot and check robot operations using the setting selection boxes.



Set the coordinates of the robot



Check robot operations

# FH Vision series product range

The product range includes general-use Smart Cameras and high-speed, high-accuracy vision systems. You can choose the right one according to your requirements for speed and accuracy of each process. Both FH Series and FHV7 Series have the common user interface and operating procedures, so it is possible to share the same image inspection method across the production line. This reduces the time for operator training. The compatibility of setting data enables you to upgrade hardware easily when speed and accuracy enhancement is needed.

For various types of inspections	For processes requiring high speed and high resolution	
Smart Camera FHV7 Series	Vision System FH Series	
		
FHV7H	FH-2050	FH-5050

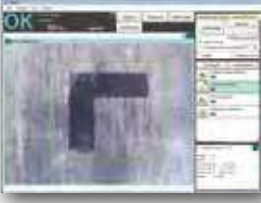
Hardware Grade	Performance <sup>*1</sup>	★	★★	★★★
	No. of cameras	1	8	8
	Resolution	0.4 Mpix 5 Mpix	1.6 Mpix 6.3 Mpix	3.2 Mpix 12 Mpix

One Software	Screens	<div style="display: flex; justify-content: space-around;"> <div style="text-align: center;"> <p>Main screen</p>  </div> <div style="text-align: center;"> <p>Measurement flow setting screen</p>  </div> <div style="text-align: center;"> <p>Measurement condition setting screen</p>  </div> </div>
	Image logging format	<div style="display: flex; justify-content: space-around; align-items: center;"> <div style="border: 1px solid black; padding: 5px;">JPEG</div> <div style="border: 1px solid black; padding: 5px;">BMP</div> <div style="border: 1px solid black; padding: 5px;">IFZ <small>(Omron format)</small></div> </div>
	Setting data	Compatible <sup>*2</sup>

\*1. ★: The more stars, the higher the performance.

\*2. Settings for the common functions can be shared between series.

# Inspection features/processing items

Most frequently used inspection features are in the FHV7, based on typical usage of the FH Series.

Group	Processing Item	FHV7 Series	FH Series
Inspection tool	Search	✓	✓
	Flexible Search	✓	✓
	Sensitive Search	✓	✓
	ECM Search	-	✓
	EC Circle Search	-	✓
	Shape Search II	-	✓
	Shape Search III	✓	✓
	EC Corner	-	✓
	Ec Cross	-	✓
	Classification	✓	✓
	Edge Position	✓	✓
	Edge Pitch	✓	✓
	Scan Edge Position	✓	✓
	Scan Edge Width	✓	✓
	Circular Scan Edge Position	✓	✓
	Circular Scan Edge Width	✓	✓
	Intersection	✓	✓
	Color Data	✓	✓
	Gravity and Area	✓	✓
	Labeling	✓	✓
	Label Data	-	✓
	Defect	-	✓
	Precise Defect	✓	✓
	Fine Matching	✓	✓
	Character Inspect	✓	✓
	Date Verification	✓	✓
	Model Dictionary	✓	✓
	2DCode II	✓	✓
	2DCode	✓	✓
	Barcode	✓	✓
OCR User Dictionary	✓	✓	
OCR	✓	✓	
Circle Angle	-	✓	
Glue Bead Inspection	✓	✓	
Input Image	Camera Image Input	-	✓
	Camera Image Input FH	-	✓
	Camera Image Input FHV	✓	✓
	Camera Image Input HDR	-	✓
	Camera Image Input HDR Lite	-	✓
	Photometric Stereo Image Input	-	✓
	Camera Switch	-	✓
	Measurement Image Switching	✓	✓
	Multi-trigger Imaging	✓	✓
	Multi-trigger Imaging Task	✓	✓
Compensate image	Position Compensation	✓	✓
	Filtering	✓	✓
	Background Suppression	✓	✓
	Brightness Correct Filter	✓	✓
	Color Gray Filter	✓	✓
	Extract Color Filter	✓	✓
	Anti Color Shading	✓	✓
	Stripes Removal Filter II	✓	✓
	Polar Transformation	✓	✓
	Trapezoidal Correction	✓	✓
	Machine Simulator	-	✓
	Image Subtraction	✓	✓
	Advanced filter	✓	✓
	Panorama	-	✓

Group	Processing Item	FHV7 Series	FH Series
Support measurement	Unit Macro	-	✓
	Unit Calculation Macro	-	✓
	Calculation	✓	✓
	Line Regression	✓	✓
	Circle Regression	✓	✓
	Precise Calibration	✓	✓
	User Data	-	✓
	Set Unit Data	-	✓
	Get Unit Data	-	✓
	Set Unit Figure	-	✓
	Get Unit Figure	-	✓
	Trend Monitor	✓	✓
	Image Logging	✓	✓
	Image Conversion Logging	✓	✓
	Data Logging	-	✓
	Elapsed Time	✓	✓
	Wait	✓	✓
	Focus	-	✓
	Iris	-	✓
	Parallelize	✓	✓
	Parallelize Task	✓	✓
	Statistics	✓	✓
	Reference Calib Data	✓	✓
	Position Data Calculation	✓	✓
	Stage Data	✓	✓
	Robot Data	✓	✓
	Vision Master Calibration	✓	✓
	PLC Master Calibration	-	✓
	Convert Position Data	✓	✓
	Movement Single Position	✓	✓
	Movement Multi Points	✓	✓
	Detection Point	-	✓
	Manual Position Setting	-	✓
	Camera Calibration	✓	✓
	Data Save	-	✓
Conveyor Calibration	-	✓	
Scene	✓	✓	
System Information	✓	✓	
Branch	Conditional Branch	-	✓
	End	✓	✓
	DI Branch	-	✓
	Control Flow Normal	-	✓
	Control Flow PLC Link	-	✓
	Control Flow Parallel	-	✓
	Control Flow Fieldbus	-	✓
	Selective Branch	-	✓
	Conditional Execution (If)	✓	✓
	Conditional Execution (Else)	✓	✓
	Loop	✓	✓
	Loop Suspension	✓	✓
	Select Execution(Select)	✓	✓
	Select Execution(Case)	✓	✓
	Output result	Result Output (I/O)	✓
Result Output(Message)		✓	✓
Data Output		-	✓
Parallel Data Output		-	✓
Parallel Judgement Output		-	✓
Fieldbus Data Output		-	✓
Display result	Result Display	✓	✓
	Display Image File	-	✓
	Display Last NG Image	✓	✓
	Conveyor Panorama Display	-	✓
	Display Image Hold	✓	✓

Note : Refer to the datasheet for details of processing items.

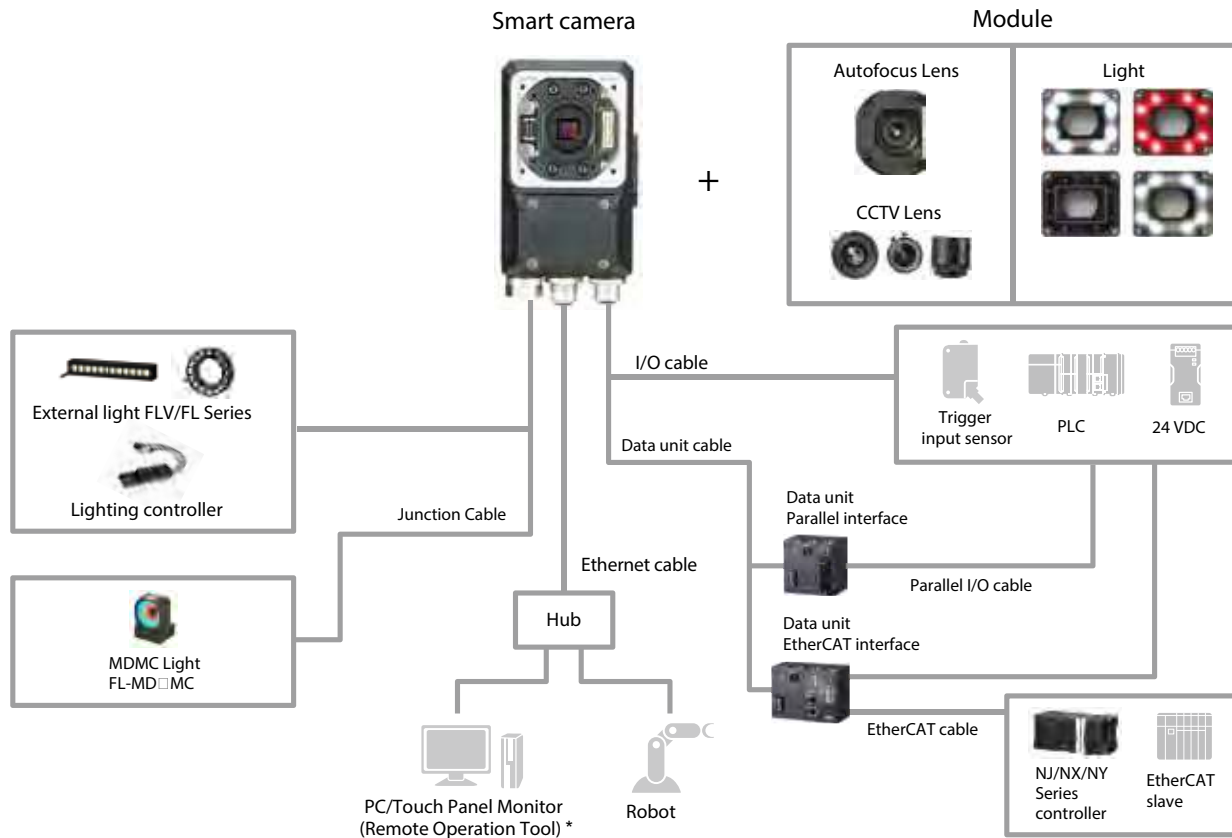

## Model selection

To select a model of Smart Camera, use the WEB Selector.  
<https://automation.omron.com/en/us/products/family/FHV7>

With certain module types, the operation of some combinations cannot be guaranteed. Use the Web Selector to select the correct combination of image sensor, lens, resolution, and light.



**OMRON AUTOMATION AMERICAS HEADQUARTERS** • Chicago, IL USA • 847.843.7900 • 800.556.6766 • [automation.omron.com](http://automation.omron.com)

**OMRON CANADA, INC. • HEAD OFFICE**  
 Toronto, ON, Canada • 416.286.6465 • 866.986.6766 • [automation.omron.com](http://automation.omron.com)

**OMRON ELECTRONICS DE MEXICO • HEAD OFFICE**  
 Ciudad de México • 52.55.5901.4300 • 01.800.386.6766 • [mela@omron.com](mailto:mela@omron.com)

**OMRON ELECTRONICS DE MEXICO • SALES OFFICE**  
 San Pedro Garza García, N.L. • 81.12.53.7392 • 01.800.386.6766 • [mela@omron.com](mailto:mela@omron.com)

**OMRON ELECTRONICS DE MEXICO • SALES OFFICE**  
 Eugenio Garza Sada, León, Gto • 01.800.386.6766 • [mela@omron.com](mailto:mela@omron.com)

**OMRON ELETRÔNICA DO BRASIL LTDA • HEAD OFFICE**  
 São Paulo, SP, Brasil • 55.11.2101.6300 • [www.omron.com.br](http://www.omron.com.br)

**OMRON ARGENTINA • SALES OFFICE**  
 Buenos Aires, Argentina • +54.11.4521.8630 • +54.11.4523.8483  
[mela@omron.com](mailto:mela@omron.com)

**OTHER OMRON LATIN AMERICA SALES**  
 +54.11.4521.8630 • +54.11.4523.8483 • [mela@omron.com](mailto:mela@omron.com)